

# Compact ServoWeld<sup>TM</sup> Actuator

Patent Pending

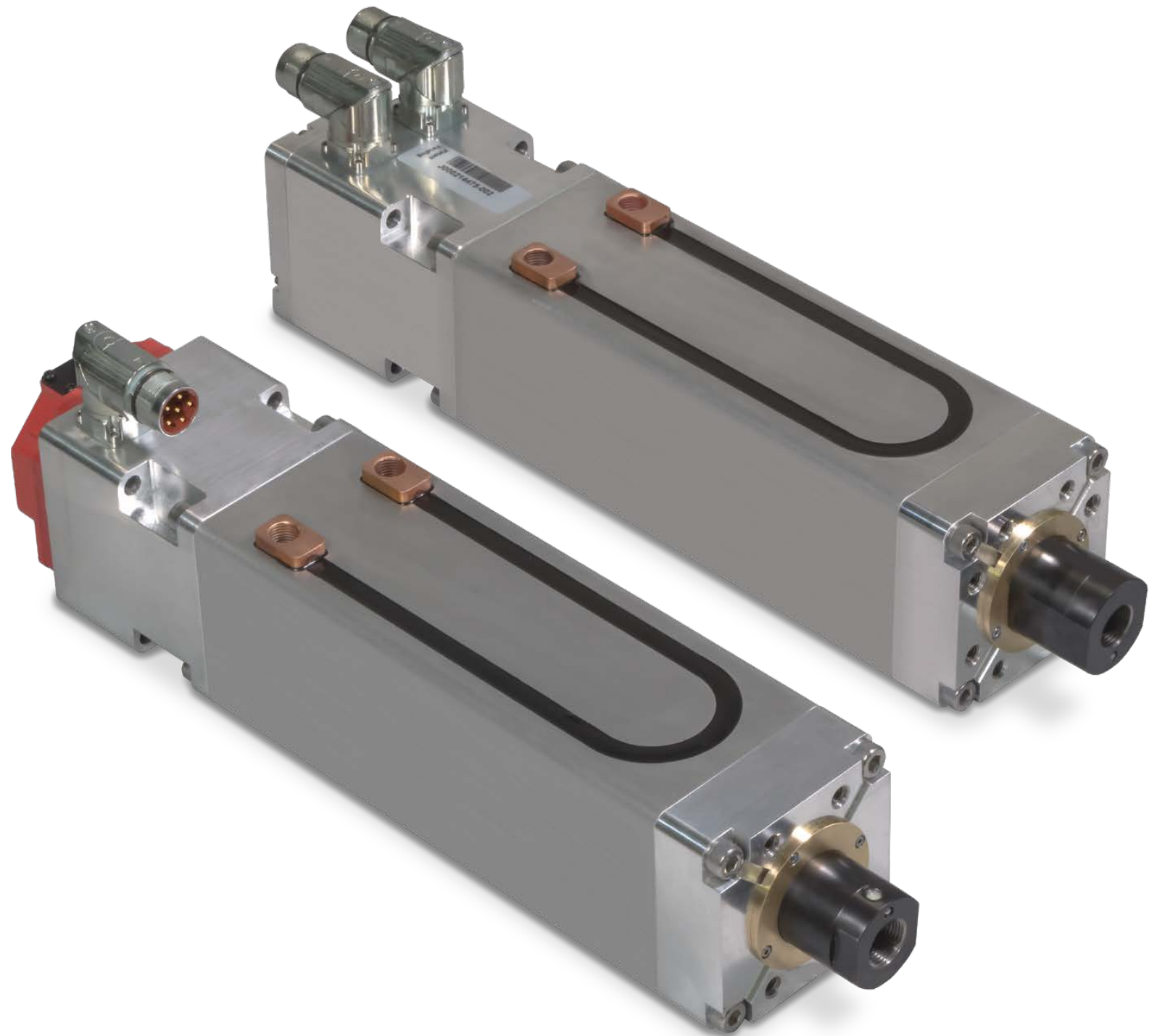

**INTEGRAL MOTOR HIGH THRUST ACTUATOR**

# ServoWeld CSWX

Tolomatic is the world's leading manufacturer of integrated servo actuators for resistance spot welding, used by the world's top weld gun OEM's and numerous global vehicle manufacturers.



## Superior Integrated Servo Motor Actuators

Tolomatic's ServoWeld family of integrated servo actuators are designed for best-in-class performance with the factors that are most important for resistance spot welding gun applications.

### NUMBER OF WELDS/ PRODUCT LIFE

Tolomatic's superior roller screw design has the **highest dynamic load rating for more welds** than any competitive technology (other roller screws, ball screw, pneumatic).

### FORCE REPEATABILITY

Skewed winding designed for welding minimizes motor cogging and **provides industry best actuator force repeatability:** •  $\pm 3\%$  Over the Lifetime of the Actuator

### EFFICIENCY

All elements of actuator (winding, screw, rod scraper, bearings) are designed to optimize the efficiency of the actuator system and provide the **most energy efficient solution on the market.**

### WELDS/ MINUTE

All elements of the actuator (winding, screw, rod scraper, bearings) are designed to last and run as cool as possible in welding applications, with the ability to add water cooling as an option. This means **more welds per minute than any competitive technology** (other roller screws, ball screw, pneumatic).

### WEIGHT

Tolomatic integrated servo actuators minimize weight when designed into the weldgun. Additionally, Tolomatic can customize actuators for a specific weldgun applications to provide **industry leading light weight designs.**

### LIFETIME COST

By building the longest lasting, most efficient and highest weld per minute actuators on the market, Tolomatic actuators provide the **lowest total cost per spot weld.**

## ServoWeld Applications

PINCH STYLE

"X" STYLE

"C" STYLE

# Typical Robotic ServoWeld Installation

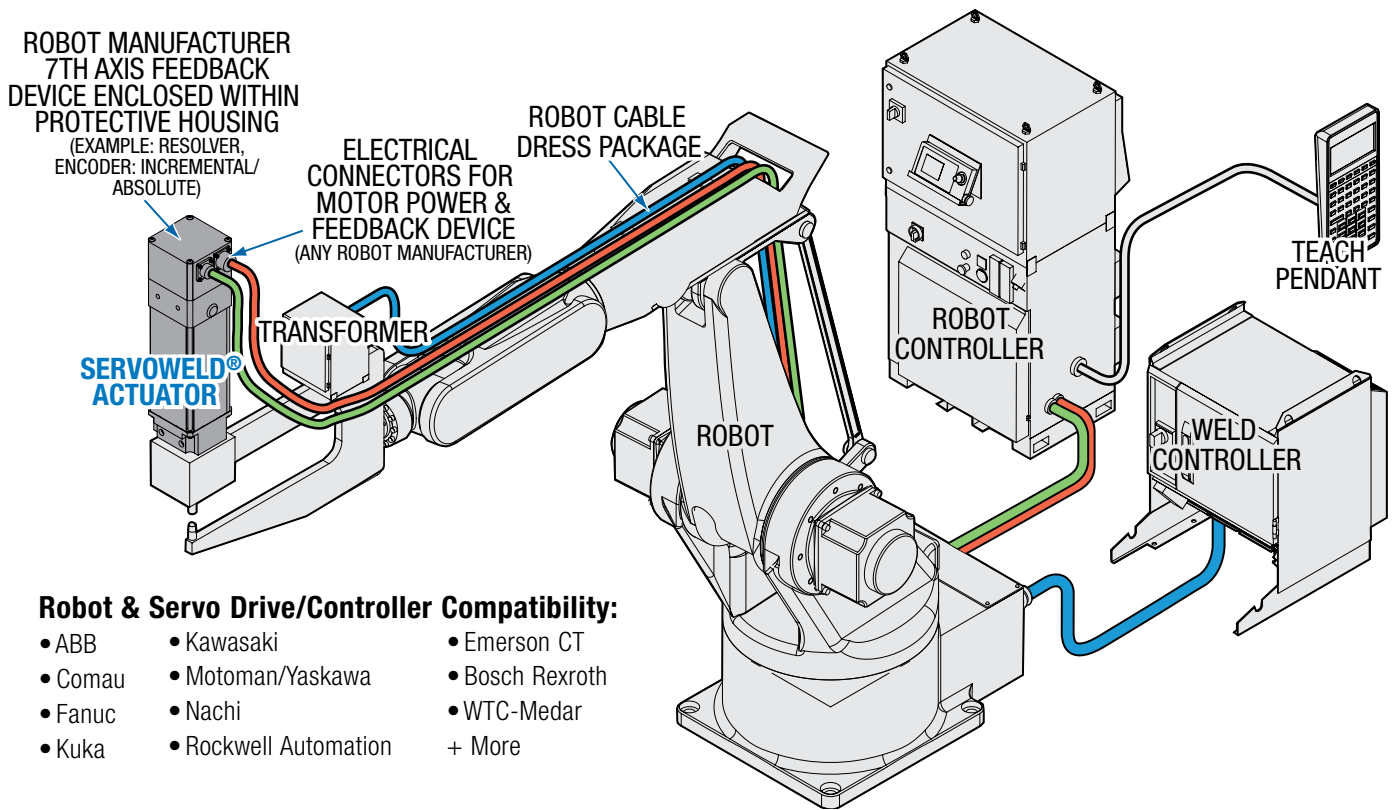

## Tolomatic Offers the Broadest, Most Capable Family of Integrated Servo Actuators for Resistance Spot Welding

Model:	GSWA	SWA/SWB	CSWX
<b>Number of Welds<sup>1</sup> (millions):</b>	20+	20+ (10+ SWB)	30+ (20+ CSW)
<b>Re-lubrication without Disassembly:</b>	Yes <sup>4</sup>	Yes	Yes
<b>Peak Force:</b>	24.5 kN [5,500 lbf]	24.0 kN [5,395 lbf] SWA 22.0 kN [4,950 lbf] SWB	18.0 kN [4,047 lbf] CSWX 15.6 kN [3,500 lbf] CSW
<b>Actuator Output Force<sup>2</sup> (Lifetime) Repeatability:</b>	± 3%	± 3% (± 5% SWB)	± 3%
<b>Weight (size 33, 3)<sup>3</sup> (size 44, 4)<sup>3</sup>:</b>	8.3 kg [18.3 lb] 13.8 kg [30.4 lb]	7.2 kg [15.9 lb] 14.2 kg [31.2 lb]	min: 10.2 kg [22.6 lb]
<b>Water Cooling:</b>	Optional	Optional	Optional
<b>Manual Override:</b>	Optional	No	Optional
<b>Full Force Direction:</b>	Push and Pull	Push	Push and Pull

<sup>1</sup> Based on properly lubricated ServoWeld unit used as recommended in user manual. Weld schedule, tip force, environment and lubrication are factors in the total number of welds achievable with ServoWeld actuators.

<sup>2</sup> At weld force

<sup>3</sup> Weight varies with choice of feedback device and mounting options

<sup>4</sup> Some exceptions, see GSWA user manual

# CSWX INTEGRATED MOTOR ACTUATOR

## ENDURANCE TECHNOLOGY<sup>SM</sup>

A Tolomatic Design Principle

*Endurance Technology features are designed for maximum durability to provide extended service life.*

	CSWX
Typical Weld Estimated Life	30 million
Warranty	24 months
Roller Screw	RN05XR & RN10
Motor	3 stack & 4 stack

### REPEATABILITY

Force repeatability of  $\pm 3\%$  for entire life of actuator

### PEAK FORCE

18 kN (4047 lbf)

### INTEGRATED WATER COOLING OPTION

- 23% more efficient compared to external designs
- Allows for increased duty cycle and welds/hour

### LARGE THRUST TUBE

40% larger diameter for greater stability

### OPTIONAL INTEGRATED ANTI-ROTATE

Optional machined 'Double-D' thrust rod designed to provide internal anti-rotation

### ADDITIONAL OPTIONS:

- Long Stroke
- Manual Override

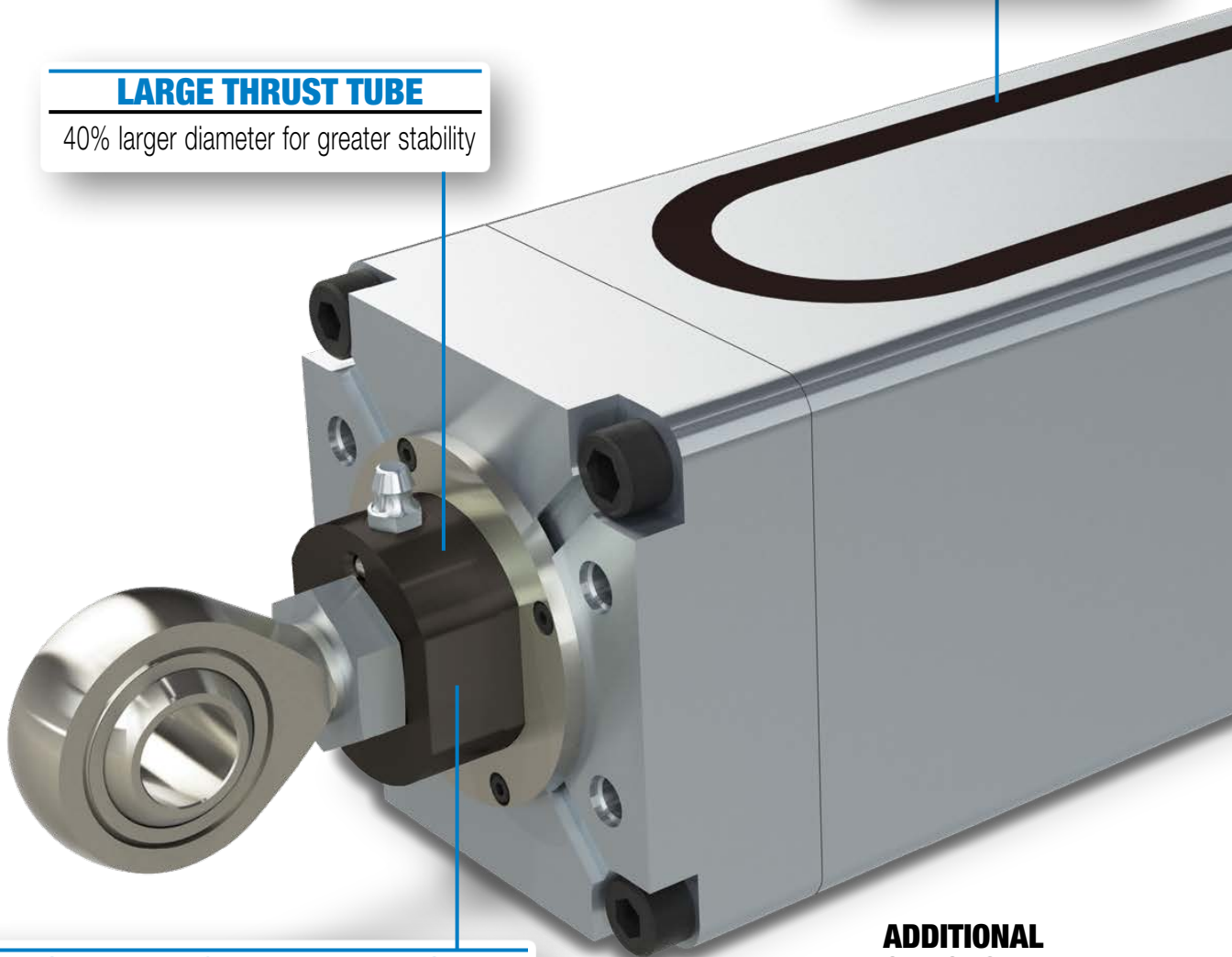

## INTEGRATED FORCE FEEDBACK OPTION

- Integrated Piezo-electric sensor
- Scaled output 0-10 V

## STANDARD STROKE LENGTHS

- 160 mm (6.3 in)
- 200 mm (7.9 in)
- 250 mm (9.8 in)
- 300 mm (11.8 in)

## HIGH SPEED

- 10 mm lead option
- 700 mm/s (27.5 in/sec)

## MID-TRUNNION MOUNTING



Rectangular extrusion is easy to adapt to a wide variety of mounting locations



## TOLOMATIC PLANETARY ROLLER SCREW



- 5mm XR
- 10mm

# ServoWeld CSWX - Integrated Motor Actuator

Table 1: Performance & Mechanical Specifications:

SERIES		CSWX			
FRAME SIZE	mm	90.0			
	in	3.54			
MOTOR WINDING		V23 / V43		V24 / V44	
NUT/SCREW		RN05XR	RN10	RN05XR	RN10
SCREW LEAD	mm	5.0	10.0	5.0	10.0
PEAK FORCE	kN	15.8	7.9	18.0	10.5
	lbf	3560	1780	4047	2350
MAX. VELOCITY	mm/sec	342 / 350	683 / 700	350	700
	in/sec	13.5 / 13.8	26.9 / 27.6	13.8	27.6
SCREW DLR (DYNAMIC LOAD RATING)	kN	91.7	76.4	91.7	76.4
	lbf	20,623	17,175	20,623	17,175
NOMINAL BACK DRIVE FORCE	N	405	205	405	205
	lbf	91	46	91	46
WEIGHT*	kg	10.9	10.9	11.4	11.4
	lbf	24.0	24.0	25.1	25.1
STROKE	mm	160	160	160	160
	in	6.3	6.3	6.3	6.3
BASE INERTIA	kg-cm <sup>2</sup>	5.5	5.5	6.5	6.5
	lb-in	1.9	1.9	2.2	2.2
MAX. SIDE LOAD (150 mm)	N	75			
	lbf	17			
AMBIENT TEMP ** RANGE	°C	0 to 50			
	°F	32 to 122			
IP RATING	Standard IP65 (static)				
AGENCY LISTINGS	 				

## WEIGHT SUMMARY

Stroke		Weight		
			Min.	Max.
160	mm	kg	10.24	12.84
	6.3 in	lb	22.57	28.31
200	mm	kg	10.96	13.64
	7.9 in	lb	24.16	30.07
250	mm	kg	11.86	14.64
	9.8 in	lb	26.14	32.28
300	mm	kg	12.76	15.64
	11.8 in	lb	28.12	34.48

Table 2: CSWX Weights

	Actuator Base Weight*	Add For Head Options			Round Rod Add For Stroke Length			Double D Rod Add For Stroke Length		
		Round Rod +94mm Head	Dbl-D +90mm Head	Dbl-D +94mm Head	200 mm (7.9 in)	250 mm (9.8 in)	300 mm (11.8)	200 mm (7.9 in)	250 mm (9.8 in)	300 mm (11.8)
kg	9.661	0.028	0.238	0.273	0.72	1.62	2.52	0.80	1.80	2.80
lb	21.3	0.06	0.52	0.6	1.59	3.57	5.56	1.76	3.97	6.17

\*3 Stack Motor, Round Rod, 90mm Head, RN05, 160mm Stroke

	Add For Screw Type		Add For Feedback Device					Add For Option			
	RN05xR	RN10	Kuka	ABB	Fanuc A1000/A128	Fanuc A64 Covered	Sick	4-Stack Motor	Brake	Water Cooling	Trunnion
kg	0.066	0.076	0.816	0.864	0.576	0.933	0.66	0.63	0.505	0.183	0.579
lb	0.14	0.17	1.8	1.91	1.27	2.06	1.46	1.39	1.11	0.4	1.28

# ServoWeld CSWX - Integrated Motor Actuator

**Table 3: Motor Specifications:**

SERIES		CSW_				
MOTOR WINDING / MOTOR VOLTAGE		_V23	_V43	_V24	_V44	
TORQUE CONSTANT ( $K_t$ )	N-m/A Peak	0.66	1.27	0.64	1.28	
	in-lb/A Peak	5.8	11.3	5.7	11.4	
VOLTAGE CONSTANT ( $K_e$ )		V/Krpm Peak	79.8	154	77.6	155.1
STALL TORQUE	Radiant Cooled	N-m	4.3	4.3	5.7	5.7
		in-lb	38.1	38.1	50.1	50.1
	Water Cooled	N-m	9.7	9.7	13.4	13.4
		in-lb	86.1	86.1	118.1	118.1
CONTINUOUS STALL CURRENT	Radiant Cooled	$A_{RMS}$	5.2	2.6	7.2	3.6
	Water Cooled	$A_{RMS}$	12.3	6.1	17.3	8.7
PEAK TORQUE	N-m	16.6	16.6	21.9	21.9	
	in-lb	146.8	146.8	194.1	194.1	
PEAK CURRENT		$A_{RMS}$	20.3	10.1	29.0	14.5
RESISTANCE		Ohms	2.07	8.28	1.14	4.56
INDUCTANCE		mH	3.80	15.00	2.24	9.82
BUS VOLTAGE		$V_{RMS}$	230	460	230	460
SPEED @ RATED V		RPM	4100	4200	4200	4200
NO. OF POLES			8	8	8	8

## SIDE LOADING

Some weld gun designs may subject the actuator to excessive side loading reducing overall service life. Measures are required, especially in "C" style designs, to limit side loading. For life optimization Tolomatic recommends side loads of less than 5% of axial load (thrust rod output force) for all roller screw configurations.

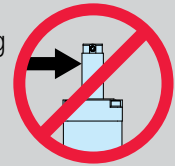

## CSW\_ SIDE LOAD SPECIFICATIONS

at 150 mm (6 in)

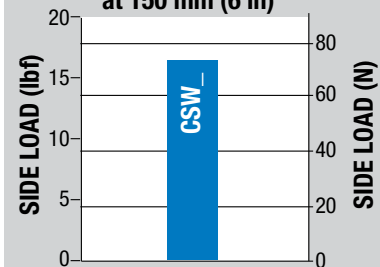

### MOTOR WINDING

\_V23  
\_V43 = 3 Stack Motor

\_V24  
\_V44 = 4 Stack Motor

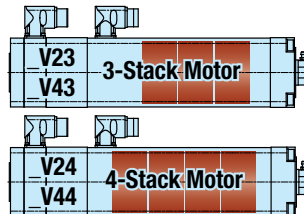

## BRAKE CONSIDERATIONS

An un-powered SW will require a brake to maintain its position if the force on the actuator exceeds Back Drive Force listed in Table 1.

A brake can be used with the actuator to keep it from backdriving, typically in vertical applications. A brake may be used for safety reasons or for energy savings allowing the actuator to hold position when un-powered.

NOTE: The optional Spring-Applied / Electronically-Released Brake requires 24V power.



**Table 4: Brake Specifications:**

	SERIES	CSW_
ROTOR INERTIA	gm-cm <sup>2</sup>	260
	oz-in <sup>2</sup>	1.422
CURRENT	Amp	0.67
HOLDING TORQUE	N-m	5.0
	in-lb	44
ENGAGE TIME	mSec	35
ENGAGE TIME WITH DIODE	mSec	80
DISENGAGE TIME	mSec	25
VOLTAGE	Vdc	24

Table 5: Dimensions

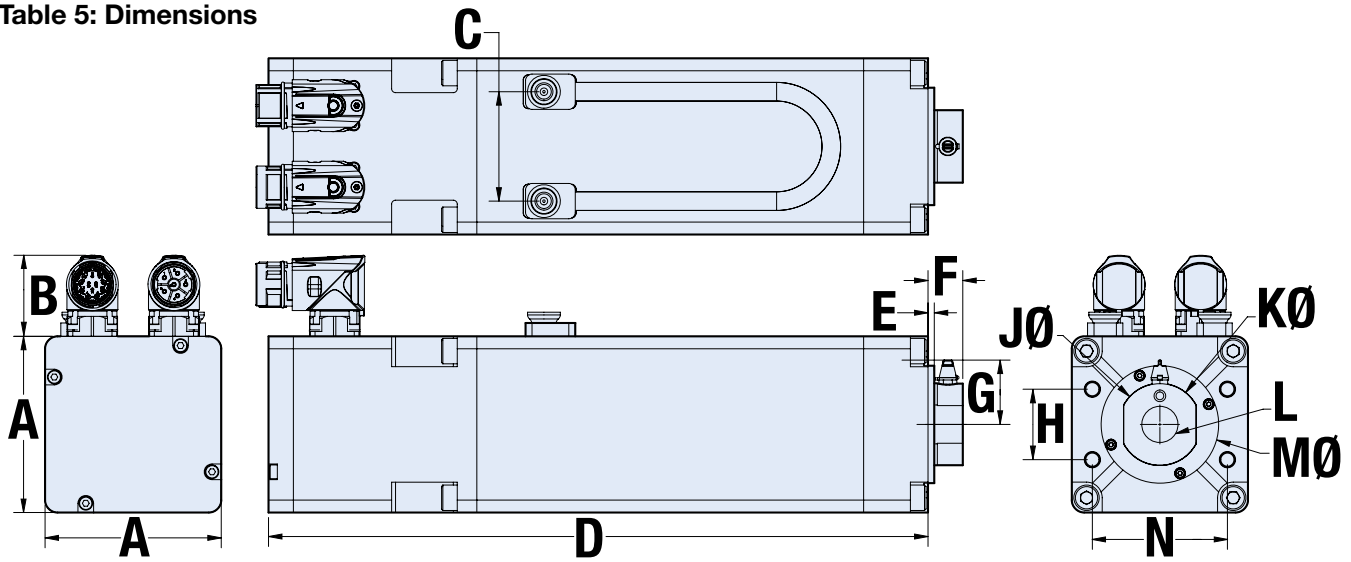

	CSWX3
A	90.00
B	41.41
C	55.88
D	396.8
E	3.2
F	17.8
G	32.86

Dimensions in millimeters

	CSWX3
H	36.00
J	42.00
K	41.70
L	M20X1.5-6H 40.0
M	60.00
N	69.00

	CSWX3
A	3.543
B	1.630
C	2.200
D	15.62
E	0.13
F	0.70
G	1.294

Dimensions in inches

	CSWX3
H	1.417
J	1.654
K	1.642
L	M20X1.5-6H 1.58
M	2.362
N	2.717

## CSWX Performance

Graph 1: Performance:

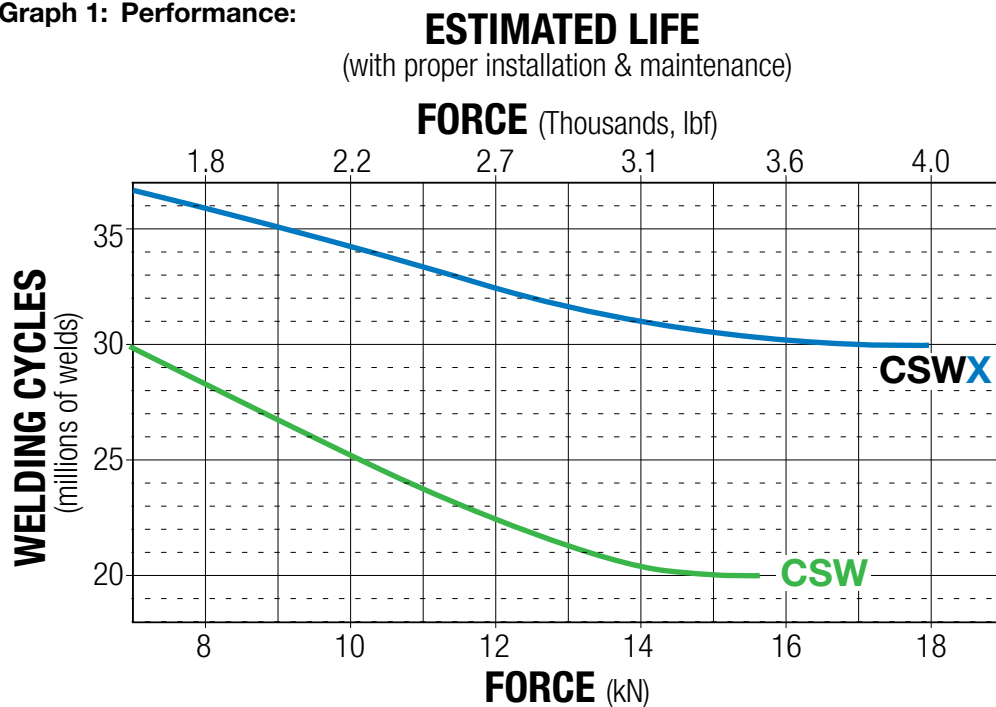



# Complete Verification Testing is Performed on Every Actuator

Every ServoWeld actuator has to pass rigorous testing at our factory. With this extra quality step we provide peace of mind to our customers and enable them to start their production faster, worry free!



Functional unit testing for hundreds of cycles quantifies stroke, length, torque under no load, input current vs force standard deviation.

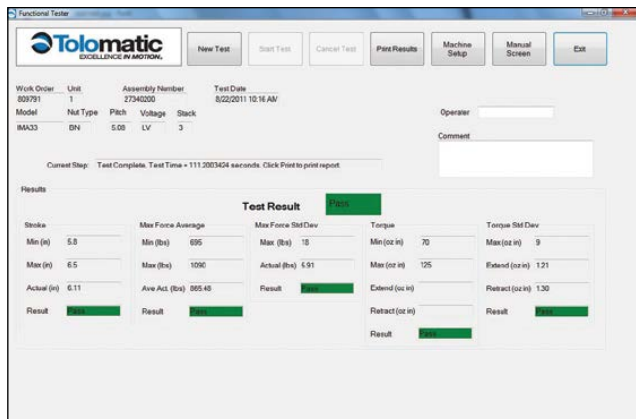

Testing parameter results in progress for the Functional Test procedure.



Final system test ensures the feedback device is properly aligned with the ServoWeld motor poles.

We verify the performance of each individual unit before delivery to ensure they conform to Tolomatic's high standard of performance.

## 1. High POT (High Potential/High Voltage Test)

This standard electric motor test procedure is a 3-part test that checks the insulation system of the assembly to verify proper armature and thermal wire insulation.

## 2. Electronic phasing of ServoWeld® and feedback device (Encoder, Resolver, Feedback Device)

Using a fixed current and a specially designed fixture the feedback device is physically and electronically aligned relative to the phasing of the ServoWeld motor.

## 3. Functional Testing

Performed with Tolomatic motion control components and dedicated data acquisition equipment. Operated for hundred of cycles, this test quantifies these parameters - stroke length, torque under no load, input current vs force average, input current vs force standard deviation - using an electronic load cell in conjunction with data acquisition equipment.

## 4. Tolomatic System Test

Using a single-axis control unit the test ensures that the feedback device is properly aligned with the poles of the ServoWeld motor.

# ServoWeld Application Guidelines

**SIDE LOADING:** Some weld gun designs may subject the actuator to excessive side loading, reducing overall service life. The GSWA33, GUIDED actuator will accommodate side loading. For other ServoWeld configurations, measures are required, especially in “C” style designs, to limit side loading. For life optimization Tolomatic recommends side loads of less than 5% of axial load (thrust rod output force) for all roller screw configurations and less than 1% of axial load for all ball screw configurations.

For maximum service life, external guiding is recommended to minimize side loading to the thrust rod and provide consist weld gun movable tip/fixed tip alignment throughout service life.

**THRUST ROD WIPER/SCRAPER:** For maximum service life, measures should be taken to reduce/eliminate contamination, weld slag, and water in the thrust rod wiper/scrapper interface area. Implementation of industrial thrust rod boot and/or deflective device can be effectively utilized in this area.

**CABLES:** Shielded power & feedback cables are recommended to minimize electrical noise/grounding issues. Electrical noise or inadequate grounding can corrupt the feedback device signal.

**RSW SERVO SYSTEM CALIBRATION:** RSW weld gun servo system consists of robot 7th axis amplifier, robot feedback device, robot RSW software, weld gun chassis, & ServoWeld.

For optimal RSW weld gun servo system performance the calibration process should include maximum weld tip force from the production weld schedule, tip dress force, and multiple weld tip forces in-between. Utilizing all the available robot manufacturer force table inputs will provide best RSW weld gun servo system performance. The same weld tip part contact speed should be used for both RSW weld gun servo system calibration and production weld schedule.

**WELD TIP/PART CONTACT SPEED:** Tolomatic testing confirms the highest ServoWeld repeatability (**INPUT CURRENT** verses **OUTPUT FORCE**) at a weld tip part contact speed of 25mm/second or less. Speeds greater than 25mm/second can create “impact contribution” to the weld force. This impact contribution to the weld force deteriorates prior to completion of the weld cycle.

**ROBOT CARRIED APPLICATIONS:** Robot carried RSW gun applications have reduced exposure to water pooling/water ingress by virtue of the continuous robot movement and various RSW gun positions. In addition, in robot carried applications positioning of the RSW gun can be programmed as part of the weld cap change program/routine to eliminate ServoWeld exposure to water. (ServoWeld above weld caps)

**ROBOT MANUFACTURER SERVO FILE:** Robot manufacturer servo parameter files for operation of ServoWeld are available only from the robot manufacturer. Each robot manufacturer creates 3rd party motor servo parameter files, validates operation of ServoWeld via their 7th axis, and maintains servo motor parameter file for operation of ServoWeld.

**TOOL CHANGER APPLICATIONS:** Weld gun storage fixture in cell should position weld gun so movable electrode is not loading ServoWeld thrust rod - back driving the ServoWeld. Weld gun tips should be positioned to weld gun closed at low force prior to disconnect from robot/tool changer. Consider ServoWeld configured with integral brake option.

**FIXED / PEDESTAL APPLICATIONS:** One of the more challenging RSW applications is a pedestal RSW gun, ServoWeld mounted vertical – thrust rod up. Measures should be taken to reduce and/or eliminate the ServoWeld to water exposure, water pooling/spray in the access areas of the ServoWeld unit to maximize overall service life.

- Pedestal RSW guns that can be mounted with the ServoWeld vertical – thrust rod down should be considered.
- Pedestal RSW guns that must be mounted with the ServoWeld vertical – thrust rod up should be mounted at an angle of a least 10 – 15° to minimize water pooling.
- Water channels on interfacing mounting components of the ServoWeld/RSW Gun to minimize water pooling
- Any RSW gun applications that are suspect for water exposure should utilize an external deflector (bib) or a thrust rod boot to keep the water away from the thrust rod wiper/scrapper interface area.
- Any RSW gun application that is suspect for water exposure should consider utilizing a manual shut-off valve in the water saver circuit at the RSW gun. Shutting off the water prior to weld cap change can significantly reduce water exposure issues in the RSW gun environment.
- Pedestal RSW gun applications should have the mating electrical connectors (90 degree) on the cable dress package facing down with the cable dress cables looped to reduce water ingress via the electrical connectors (power/feedback).
- Allow adequate cable length so the cables are not in tension.
- Molded mating electrical connectors on the cable dress package for pedestal RSW gun applications
- Confirming full engagement of the cable dress connector to the appropriate mating receptacle on ServoWeld.

# ServoWeld CSW<sub>X</sub> Integrated Motor Actuators

## Ordering

MODEL SELECTION (MUST BE IN THIS ORDER)

**C S W X 3 S V 2 4 W 2 F 1 C S 1 R N 1 0 S 2 0 0 A 2 H F 1 - F A**

### MODEL

**CSWX** Compact ServoWeld X

### SIZE

**3** 3 Series; 90 mm square

### THERMAL PROTECTION

**F** Fanuc Proprietary  
**R** 600 ohm resistor in series with temperature switch  
**P** PT1000  
**S** Standard, temp. switch normally closed

### MOTOR VOLTAGE & STACKS

**23** 230 Vac, Motor Voltage, 3 Stack Winding  
**43** 460 Vac, Motor Voltage, 3 Stack Winding  
**24** 230 Vac, Motor Voltage, 4 Stack Winding  
**44** 460 Vac, Motor Voltage, 4 Stack Winding

### COOLING

**R1** Radiant Cooled  
**W1** Water Cooling, G 1/4 Thread, Connector Side  
**W2** Water Cooling, G 1/4 Thread, Opposite Connector

### FEEDBACK, CONNECTOR, WIRING

**A1** ABB Resolver  
**C1** Comau Resolver  
**E1** Emerson CT Hiperface  
**F1** Fanuc a128  
**F2** Fanuc a64  
**K1** Kuka Resolver  
**M1** Motoman Absolute  
**N1** Nachi Absolute FD11 Series  
**R1** Rockwell Automation Hiperface  
**R2** Rockwell Automation Hiperface DSL  
**W1** Kawasaki Absolute E Series  
**XX** Special

### FEEDBACK SUPPLIED BY:

**CS** Customer Supplied  
**TS** Tolomatic Supplied

### BRAKE OPTION

**1** NO Brake  
**2** 24V Brake  
**3** 90V Brake

### SCREW LEAD

**RX05** Roller Nut, 5 mm lead, Extended Roller Nut  
**RN10** Roller Nut, 10 mm lead

### STROKE LENGTH

**S160** 160mm (6.3") Stroke  
**S200** 200mm (7.9") Stroke  
**S250** 250mm (9.8") Stroke  
**S300** 300mm (11.8") Stroke

### ROD END OPTIONS

**A** Female M20  
**B** Female M16  
**C** 20 mm Spherical Rod Eye  
**D** 16 mm Spherical Rod Eye

### ROD-TYPE

**1** Round  
**2** Double D (Anti-rotate)

### ACTUATOR MOUNTING

**HF1** Standard Head 4 M8x1.25 tapped holes, 69mmx36mm pattern  
**UN1** Universal head 94mm square Mid Trunnion (contact Tolomatic)

### ADDITIONAL OPTIONS

(Each separated by hyphen)  
**FA** Force Feedback  
 Manual Override  
 (Contact Tolomatic)



**Not all codes listed are compatible with all options.**

Call Tolomatic 1-800-328-2174 to determine available options and accessories based on your application requirements.

# The Tolomatic Difference Expect More From the Industry Leader:



## INNOVATIVE PRODUCTS

Unique linear actuator solutions with Endurance Technology<sup>SM</sup> to solve your challenging application requirements.



## FAST DELIVERY

The fastest delivery of catalog products... Built-to-order with configurable stroke lengths and flexible mounting options.



## ACTUATOR SIZING

Online sizing that is easy to use, accurate and always up-to-date. Find a Tolomatic electric actuator to meet your requirements.

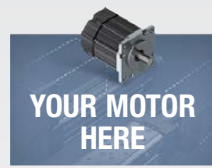

## YOUR MOTOR HERE

Match your motor with compatible mounting plates that ship with any Tolomatic electric actuator.

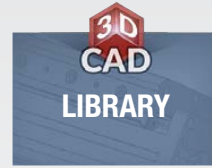

## LIBRARY

Easy to access CAD files available in the most popular formats to place directly into your assembly.



## TECHNICAL SUPPORT

Extensive motion control knowledge: Expect prompt, courteous replies to any application and product questions from Tolomatic's industry experts.

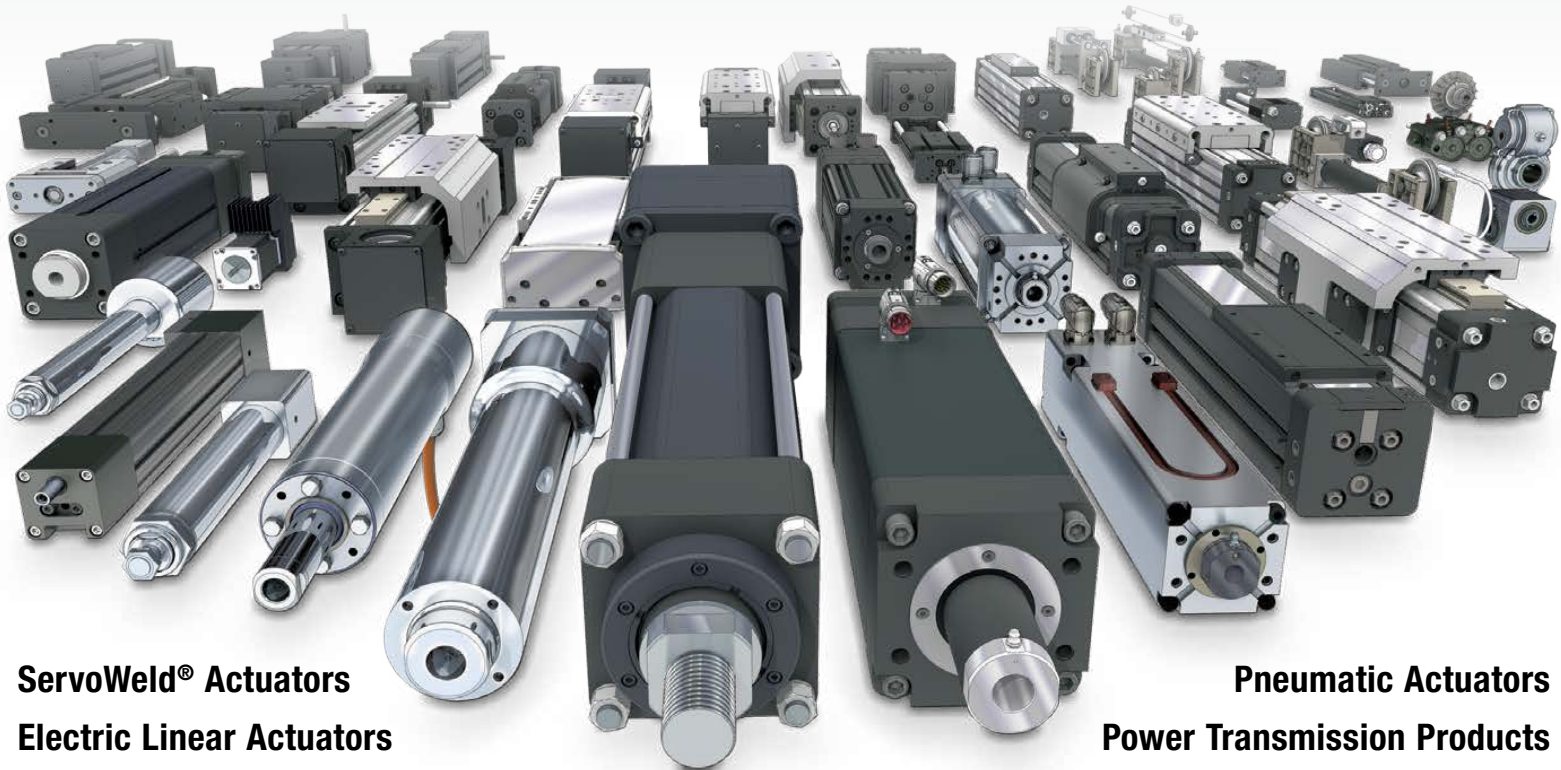

**ServoWeld<sup>®</sup> Actuators**  
**Electric Linear Actuators**

**Pneumatic Actuators**  
**Power Transmission Products**

# Tolomatic<sup>TM</sup>

EXCELLENCE *IN MOTION*

COMPANY WITH  
QUALITY SYSTEM  
CERTIFIED BY DNV GL  
= ISO 9001 =  
Certified site: Hamel, MN

### USA - Headquarters

**Tolomatic Inc.**  
3800 County Road 116  
Hamel, MN 55340, USA  
**Phone:** (763) 478-8000  
Toll-Free: **1-800-328-2174**  
sales@tolomatic.com  
[www.tolomatic.com](http://www.tolomatic.com)

### MEXICO

**Centro de Servicio**  
Parque Tecnológico Innovación  
Int. 23, Lateral Estatal 431,  
Santiago de Querétaro,  
El Marqués, México, C.P. 76246  
**Phone:** +1 (763) 478-8000  
help@tolomatic.com

### EUROPE

**Tolomatic Europe GmbH**  
Elisabethenstr. 20  
65428 Rüsselsheim  
Germany  
**Phone:** +49 6142 17604-0  
help@tolomatic.eu

### CHINA

**Tolomatic Automation Products  
(Suzhou) Co. Ltd.**  
No. 60 Chuangye Street, Building 2  
Huqiu District, SND Suzhou  
Jiangsu 215011 - P.R. China  
**Phone:** +86 (512) 6750-8506  
TolomaticChina@tolomatic.com

All brand and product names are trademarks or registered trademarks of their respective owners. Information in this document is believed accurate at time of printing. However, Tolomatic assumes no responsibility for its use or for any errors

that may appear in this document. Tolomatic reserves the right to change the design or operation of the equipment described herein and any associated motion products without notice. Information in this document is subject to change without notice.

Visit [www.tolomatic.com](http://www.tolomatic.com) for the most up-to-date technical information